

FDCIO181-2 Input/Output Module Product Manual

Characteristic

- Microprocessor-controlled signal evaluation
- Automatic address setting, without encoder settings or DIP switch
- 2 monitored input, 2 monitored output
- LED display of input and output status
- Input lines monitored for open line or short circuit
- Prevention of noise interference through intelligent analysis of input signals
- Output lines monitored for open line or short circuit (when potential output and not activated)
- Output monitoring configurable(on/off)
- Control output for equipment 24 VDC, max. 2 A
- Power supply via FD18-BUS
- Communication with controller via FD18-BUS(detector line)
- Directly used in dry areas. Applicable in dusty and humid areas when installed in housing
- "Sticker Method" easy for commissioning

Application

Input

With the input a status can be monitored, the input can be configured by controller or configuration tools as follows:

- “Status“ input or “Alarm“ input
- Lead monitoring for open line or open line and short circuit
- When inputting status, according to different status of contact, can be set as follows:
 - Normal mode: normally open NO input
 - Inverted mode: normally closed NO input

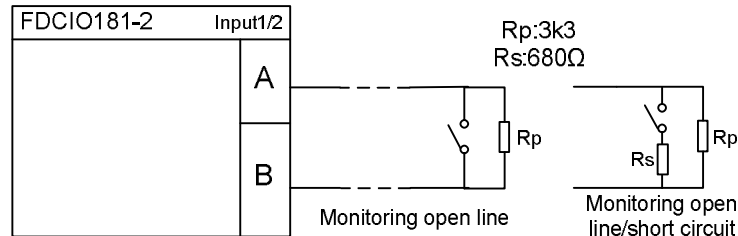

Fig. 1 connection diagram of dry contact input

Status” inputs and alarm” inputs

“Alarm“ inputs trigger an alarm as soon as the input is activated. “Status“ inputs trigger a monitoring status change as soon as they are activated.

Line monitoring and circuitry

The input lines are monitored for open line or open line and short circuit. To make these possible, resistors must be properly connected to the end of lines of the input (Fig. 1). When an open line or a short circuit occurs on one of the input lines, a fault message is transmitted to the control panel. The input must be potential-free.

Output

External power output (Default)

Normal operation (output lines monitored)

- Be used for controlling (e.g. operating a horn/strobe).
- The module switches the externally supplied 24 VDC voltage in active status on the output.
- In inactive status the output line is monitored for open line and short circuit (Fig. 3).
- The jumper on the input/output module must be plugged onto J2/J4 (Fig. 2)



Fig.2 Input/output module jumper position J2, J4

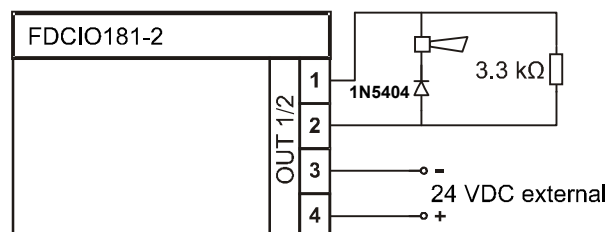

Fig.3 Connection for normal operation with output line monitored for short circuit and open line

Configuration

The following configurations are possible through controller or configuration tool:

- After activating the output remains:
 - Steady output
 - Pulse output: How long the contact remains active can be configured by controller or configuration tools (pulse duration).
- Failsafe behavior when the FD18-BUS detector line is current-free or in degraded mode. The error behavior defines the position of the output in case of an error:
 - Off: Output remains in the same position as before the error
 - Activation: Output is activated in case of an error
 - Deactivation: Output is deactivated in case of an errorThe controller does not monitor external equipment status (activated/inactivated).

Inverted operation (output lines not monitored)

- Be used for controlling (e.g. closing a door).
- The module switches the externally supplied 24 V DC voltage in active status on the output.
- In normal status there is no monitoring for open line and short circuit.
- The jumper on the input/output module must be plugged onto J2/J4 (Fig. 4).

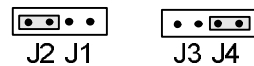

Fig. 4 Input/output module jumper position J2, J4

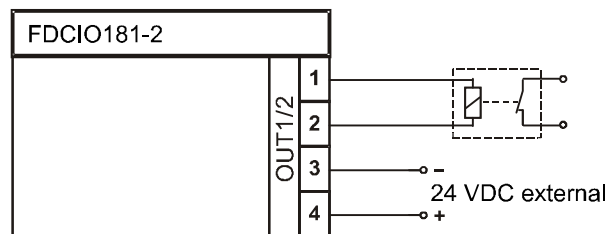

Fig. 5 Connection diagram for inverted operation, e.g. when used as door retainer.

In inactive status the 24 V DC are permanently applied to the output and may keep a door open, for example. When the output is switched to active, the output goes into "open" status (= no 24 V DC voltage) and the door is closed.

Comment:

In this example, the door would also close if the 24 VDC supply were to fail, e.g. due to a line problem (short circuit, open line).

Configuration

Under inverted mode, the following configurations are possible through controller or configuration tools :

- After activating the output remains:
 - Steady output
 - Pulse output: How long the contact remains active can be configured by controller or configuration tools (pulse duration).
- Failsafe behavior when the FD18-BUS detector line is current-free or in degraded mode. The error behavior defines the position of the output through controller or configuration tools in case of an error :
 - Off: Output remains in the same position as before the error
 - Activation: Output is activated in case of an error
 - Deactivation: Output is deactivated in case of an errorThe controller does not monitor external equipment status (activated/inactivated).

Dry contact output

Potential-free contact (Output not monitored)

- Be used for controlling (e.g. closing a door).
- Output control is not monitored.
- An externally supplied 24 V DC voltage is not needed.
- The jumper on the input/output module must be plugged onto J1/J3 (Fig. 6).

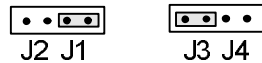

Fig.6 Input/output module jumper position J1

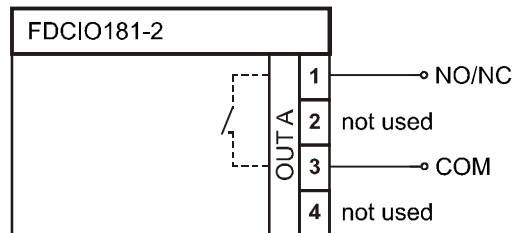

Fig. 7 Connection diagram for potential-free contact output

Configuration

The following configurations are possible by controller or configuration tools :

- The contact is active, when:
 - Normal mode: normally open NO closes
 - Inverted mode: normally closed NC opens
- After activating the output remains:
 - Steady output
 - Pulse output: How long the contact remains active can be configured by controller or configuration tools (pulse duration).
- Failsafe behavior when the FD18-BUS detector line is current-free or in degraded mode. The error behavior defines the position of the output through controller or configuration tools in case of an error:
 - Off: Output remains in the same position as before the error
 - Activation: Output is activated in case of an error
 - Deactivation: Output is deactivated in case of an error

The controller does not monitor external equipment status (activated/inactivated).

Structure

The module consists of the module carrier, the printed circuit board and the cover. The printed circuit board includes the LEDs. The LEDs indicate the states of the inputs/outputs. The cover of the printed circuit board is transparent, so that the state of the LEDs is visible even when the housing is closed.

To protect the modules from environmental influences, housing FDCH221 is optional.

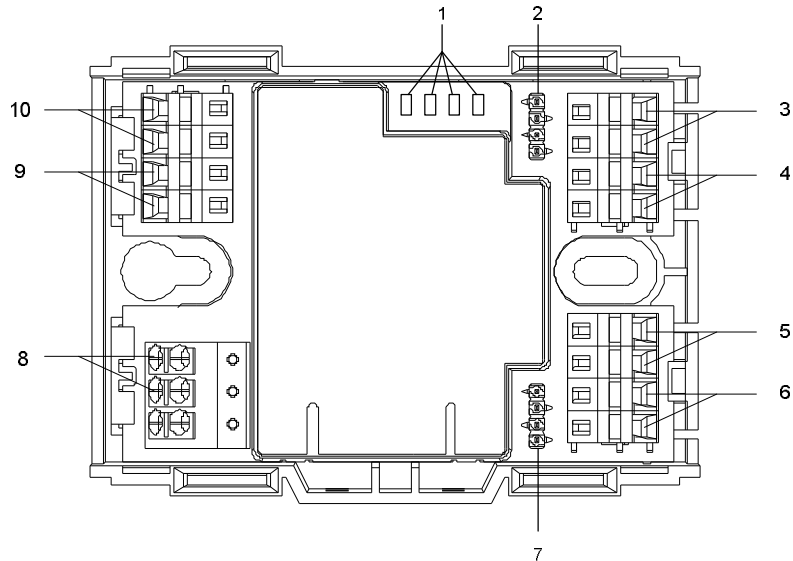





Fig.8 Overview

No.	Signification
1	LEDs for the status indication of the in-/output
2	Jumper for the polarity of the monitoring for output 1
3	Connection output 1
4	Port for the connection of the 24V supply for output 1
5	Port for the connection of the 24V supply for output 2
6	Connection output 2
7	Jumper for the polarity of the monitoring for output 2
8	Port for the connection of the FD18-BUS detection line
9	Connection input 1
10	Connection input 2

Jumper

Jumper position	Signification
 J2 J1	Output1 is not monitored.
 J2 J1	Output1 is monitored.(factory default)
 J3 J4	Output2 is not monitored.
 J3 J4	Output2 is monitored.(factory default)

If the configurations on the control panel and jumper don't match, this is recognized and an error message is triggered.



Any other jumper position is not allowed.

LED indicator

For each in-/output, one red LED indicate the status.

LED	Signification
Off	Normal operation, in/output is monitored.
Flashes every 1 s, 250ms on	Input/output activated
Input 1 LED flashes every 1s, 2...5ms on	Localization mode

Installation

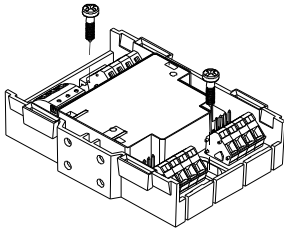

Fig. 9

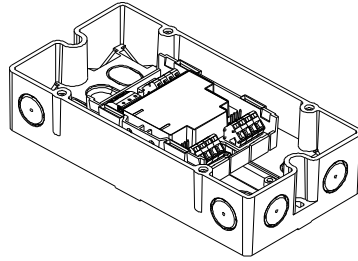

Fig. 10

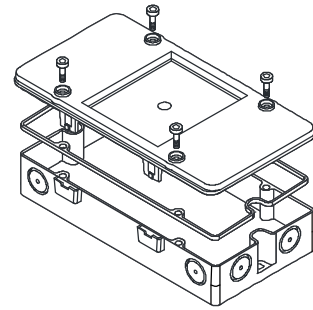

Fig. 11

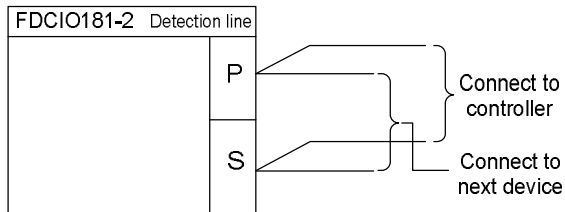

Fig. 12 Detection line connection

Preparation

1. Determine type of installation:

- Installation outside a switching cabinet or a control unit: use FDCH221 housing (Fig. 10) .
- Installation directly in a switching cabinet or a control unit: mount the module on an even surface (Fig. 9).



Damage by water!

In humid or wet environments always use FDCH221 housing!

Mounting FDCH221 housing

1. Open the housing.
2. Determine the position of the cable entries in the housing and break them out.
3. Mount the housing on an even surface with two screws (Fig. 10). Distance between holes: $182.0 \pm 1.0\text{mm}$.
4. Insert the cables and fix the cables in the housing.
5. Insert the seal and fix the lid additionally with four screws (Fig. 11) (only this way is IP65 protection guaranteed).



The housing lid is transparent. Consider a suitable installation position to make sure that the LEDs of the module are visible at any time.

Procedure with installation in the housing



CAUTION

Overheating of the in/output module!

1. Open the housing.
2. Place the module in the housing and fix it with two screws (Fig. 9/10).
3. Close the housing.

Procedure with installation on an even surface

1. Place the module on an even surface.
2. Fix the module with two screws (M4 X15) (Fig. 9). Distance between holes: $63.5 \pm 1.0\text{mm}$

Electric connection

1. Referring to Fig. 1,3,5,7,12 connect the cables to the corresponding terminals.
2. Connect resistor/ diode .The resistors must be connected at the end of the monitored line.
3. Fix the cables to the module



CAUTION

Mind the positive and negative polar when connecting the diodes.

Dimension

In:mm

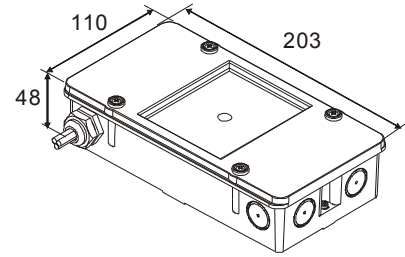
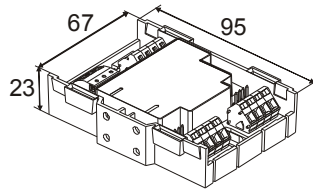

Specification

Operating voltage	12 ... 32 VDC
Operating current (quiescent)	0.56 mA
Activation current	0.85 mA
Output	
Capacity	2 A @ 24 VDC
Resistor	3.3k Ω
Diode	1N5404
Input	
- Resistor	3.3k Ω / 680 Ω
Operating temperature	0 ... +42 °C
Storage temperature	-20 ... +75 °C
Humidity	\leq 95 % rel.
Communication protocol	FD18-BUS
Connection terminals	1.0 ... 1.5 mm ²
Color	
- Housing	white, RAL 9010
- Cover	transparent
Protection category EN60529 / IEC529/GB4208-93	
- With FDCH221 housing	IP65

Details for ordering

Type	Material No.	Part No.	Designation	Weight
FDCIO181-2	S54322-F2-A1	100856218	Input/output module	0.07Kg
FDCH221	S54312-F3-A1	100686595	Auxiliary Housing (IP65)	0.250 Kg

Beijign Siemens Ceberus Electronics Ltd.
 No. 18 Xinx Road Shangdi Information Industry Base,
 Haidian District, Beijing 100085 China
 Tel.: +10 6296 2255
 Fax: +10 6298 7387
www.sbt.siemens.com

© Data and design subject to change without notice.